





# Table Of Contents:

<u>Search Engine Optimization (SEO)</u>	<u>4</u>
<u>1.1 What is SEO</u>	<u>5</u>
<u>1.2 How Search Engines Work</u>	<u>7</u>
<u>1.3 Types of SEO</u>	<u>10</u>
<u>Conclusion</u>	<u>27</u>

# Search Engine Optimization (SEO)

**In this section, you will learn about:**

1.1 What is SEO?

1.2 Types of SEO

1.3 How Search Engines Work

## 1.1 What is SEO?



Ever wondered why some websites rank better than the others do? It is because of a powerful web content technique called Search Engine Optimization, which is usually shortened to SEO. This is the art of increasing your site's natural search engine ranking, so that you rank high in the right searches.

For example, if your company sells vacuum cleaners you would expect to rank well when people look for vacuum cleaner websites. Ranking well is important because the majority of users only click on links to sites on the first page. Furthermore, it can be argued that most only click on the sites at the top of the page.

Successful SEO depends on a variety of factors. These include such elements outlined in section 1.3, such as keywords, titles, tags and internal link structures.

It also depends on how each specific search engine operates (see section 1.2) and what their expectations are.



There are, however, some safe means of ensuring your website ranks well and we will teach you how to employ those techniques. Above all those little tricks and trades, one thing is clearly important and that is quality. Modern search engines expect sites to contain quality content that is useful, factually correct and not solely designed for sales purposes (except shop fronts and selling areas of course).

## 1.2 How Search Engines Work

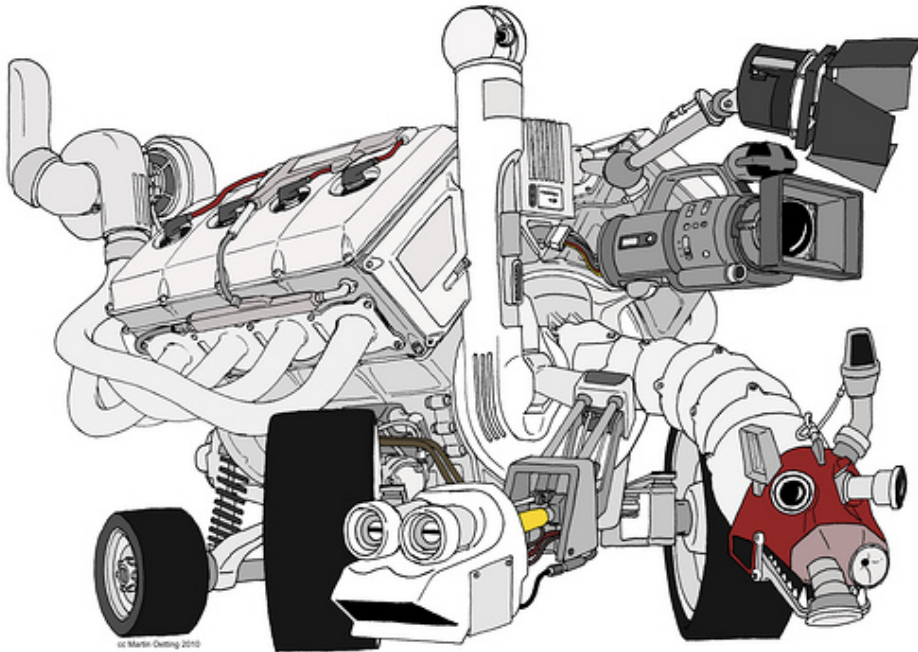

Search engines need to process millions of websites and tens if not hundreds of million webpages whenever any web search is made. The key to mastering SEO is knowing how a search engine reads your website's content and processes it for a relevant web search.

One problem in trying to understand how a search engine works is the fact that they continuously change. At the beginning of 2011, for example, Google took into account the size of a website, the number of pages it had, and how many keywords were stuffed into those pages. There were complaints and within a few months, the panda update recalculated search results to take into account perceived quality. This meant a number of sites that once ranked high, now ranked a lot lower on Google.

The first task of a search engine is to find the websites and webpages it needs to index. This is done using a type of software robot called a spider. For example, if you run a Wordpress-based website, you will be able to track how many spiders have latched onto your site by using a plugin such as StatPress Reloaded.

#### Last spiders

Date	Time	Spider	Page	Agent
January 22, 2012	12:20:56	Baidu	/tag/austin-post/	Mozilla/5.0 (compatible; Baiduspider/2.0; +http://www.baidu.com/search/spider.html)
January 22, 2012	12:07:42	Google	/tag/99/	Mozilla/5.0 (compatible; Googlebot/2.1; +http://www.google.com/bot.html)
January 22, 2012	11:57:55	MSN	/2012/01/21/108-breaths-gets-r...	msnbot/2.0b (+http://search.msn.com/msnbot.htm)_
January 22, 2012	11:57:54	MSN	/robots.txt	msnbot/2.0b (+http://search.msn.com/msnbot.htm)_
January 22, 2012	11:56:34	Google	/tag/michael-gove/	Mozilla/5.0 (compatible; Googlebot/2.1; +http://www.google.com/bot.html)
January 22, 2012	11:52:03	Baidu	/tag/capitalism-a-love-story/	Mozilla/5.0 (compatible; Baiduspider/2.0; +http://www.baidu.com/search/spider.html)
January 22, 2012	11:41:35	Google	/tag/phil-taylor/	Mozilla/5.0 (compatible; Googlebot/2.1; +http://www.google.com/bot.html)
January 22, 2012	11:33:19	Baidu	/tag/the-99-2/	Mozilla/5.0 (compatible; Baiduspider/2.0; +http://www.baidu.com/search/spider.html)
January 22, 2012	11:31:54	Google	/category/social-media-2/	Mozilla/5.0 (compatible; Googlebot/2.1; +http://www.google.com/bot.html)
January 22, 2012	11:00:14	Yandex	Page: Home	Mozilla/5.0 (compatible; YandexBot/3.0; +http://yandex.com/bots)
January 22, 2012	11:00:13	Yandex	/robots.txt	Mozilla/5.0 (compatible; YandexBot/3.0; +http://yandex.com/bots)

Each search engine, when a user makes an enquiry, refers to the word lists compiled by the spiders. Some search engines like AltaVista will list every word on every page, while others, like Google, list only tags and Meta tags. Others will base their decisions on keywords.

An important way a spider moves from one website to another is by links. When a website is linked to by another, the spider follows the link and then records all the information on the new site. This is why this book extensively covers the use of backlinks when building a website (see Part 2).

Once a search engine has an index it then ranks the sites and pages. This is done by looking at keyword density or it might be based on a system of weighting. The latter varies from search engine to search engine, but is used as a quality control filter. This means some search engines might give better index



ranking positions to academic sites than say to blogs on the same subjects. Weighting can also be applied negatively to sites that the search engine deems to be a spam site, a copy site or to sites that aim to distort their position by posting masses of cheap, badly written content.

<b>Google PR of the Backlink Page</b>	<b>PR Weight of the Backlink Page</b>
PR0	1
PR1	5
PR2	25
PR3	125
PR4	625
PR5	3,125
PR6	15,625
PR7	78,125
PR8	390,625
PR9	1,953,125
PR10	9,765,625

In order to perform well, your site needs to follow the above rules on SEO techniques and the rules below on backlinks.

## **1.3 Types of SEO**

There are a number of types of SEO. They are as follows:

1.31 Keywords

1.32 Tagging

1.33 Image Search Optimization (ISO)

1.34 Internal Linking

See Sections 2-3 for information on one of the most important elements of SEO; backlinks.

## 1.31 keywords



Keywords are often seen as one of the most important elements of SEO. Quite simply, a keyword is a brightly colored flag sticking out of the haystack with the words “needle here” emblazoned on it. But at the same time, it is pointless having such a flag if the needle is not there and especially if there is no needle.

Over the last decade or so, the importance of keywords has varied and so has the rules concerning their distribution. In the early days, search engines would pick up all words in a text. This meant that a high-ranking site would turn up in search results for terms mentioned in its text, but which were not important to the content.

This changed to a system where keywords were denoted on account of their repetition. This meant the spiders would assess a text, remove functional words and concentrate on repeated vocabulary.

An Example of Keyword Stuffing:

**“Vacuum cleaners clean carpets. Vacuum cleaners clean all surfaces. You**

need **vacuum cleaners**. **Vacuum cleaners** can be cheap or expensive. Good deals on **vacuum cleaners** are really good. You should buy high quality **vacuum cleaners** at low prices. In conclusion, buy **vacuum cleaners!**”

This led to keyword stuffing, or an attempt to make a work rank higher by filling a text with keywords above and far beyond how they would be distributed in a normal text. Search Engine updates such as Google’s Panda in 2011, were created to equate keyword stuffing, an over natural abundance of repeated terms, with spamming.

Before you do anything, you need to know what words you want to rank for which means finding out what words your target customers search for in the search engines. Once you know the words that relate to the products or services you provide, these will then become your ‘keywords’. Only when you know them, can you target them.

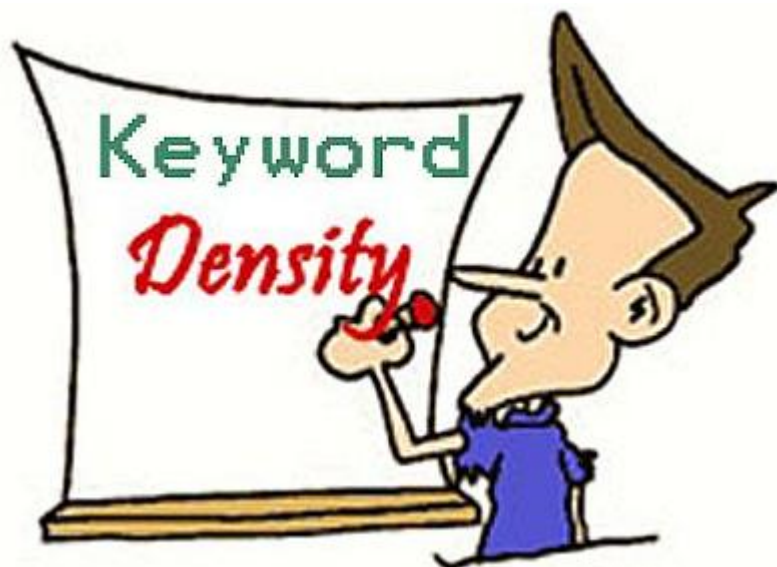

Advice varies from site to site on the frequency of modern keywords and keyword phrases, but it is generally good to have one keyword or keyword phrase per 100 words of text and no more.

Keywords can come as single words or as phrases. A keyword phrase tends to include a cluster or concentration of keyword nouns. For example “cheap reusable bags” or “high quality graphics.” The more specific keyword phrases tend to work better for smaller sites than using single keywords. This is because large multinational companies naturally have a higher rating, larger websites and so on.

Your prime objective should be finding the most relevant keywords and keyword phrases for your webpage. As this is page based, you can have different keyword phrases for each page, so long as they remain relevant.

First, before you write your page, make sure you understand what the page is about and what it is trying to say. Also, think about the title. A functional title means you can use the prime keyword phrase in the title line, and then repeat it in the webpage itself.

Second, write the page's content with the keywords in mind. Try to include the keywords once every two paragraphs on average. Of course, this means you can include such a phrase twice in one paragraph, so long as it is balanced. It is also advisable to try to use the phrase in your opening line if possible.

Warning: avoid shoehorning phrases into unnatural situations. This means you

may often have to use variations on the phrase. Variations are usually used for grammatical or syntax reasons, such as changing the tense or pluralizing a word. This is fine because the keyword phrase has changed and represents a secondary keyword phrase.

Edit your webpage and check the keyword density. If you have around 430 words, then you should have around five repetitions of the keyword phrase.

#### [What are Primary and Secondary Keywords in SEO ?](#)

[www.dailybloggr.com/.../primary-and-secondary-keywords-importa...](http://www.dailybloggr.com/.../primary-and-secondary-keywords-importa...)

8 Jul 2007 – **Keywords** are the building blocks of your blog. They are like amino acids that form the proteins for growth to your body. The right amount of ...

#### [Keyword Research Tutorial - Secondary Keywords - YouTube](#)



[www.youtube.com/watch?v=x-enOTpF6eg](http://www.youtube.com/watch?v=x-enOTpF6eg)

22 Dec 2010 - 5 min - Uploaded by Learn2MakeMoney

Visit <http://internetmarketingdiy.org/> for tutorial about how come up with **secondary keyword** for article writing ...

[More videos for secondary keywords »](#)

Another tool at your disposal is the secondary or even tertiary keyword phrase. Used less often than the primary keyword phrase and never used in the title or the first line, the secondary keyword phrase gives you a second opportunity to highlight keywords for the spiders to find.

In order to generate a secondary phrase re-read your webpage and look for any repeated themes or ideas. For example, a page on vacuum cleaners might often talk about certain accessories. Alternatively, if your primary angle of the page is the vacuum cleaner's low cost, you might also repeat its power, its convenience or other features.

Similar rules for keywords apply to secondary keyword phrases. They should not

be stuffed into the text and should not be shoehorned into the wrong sentences.

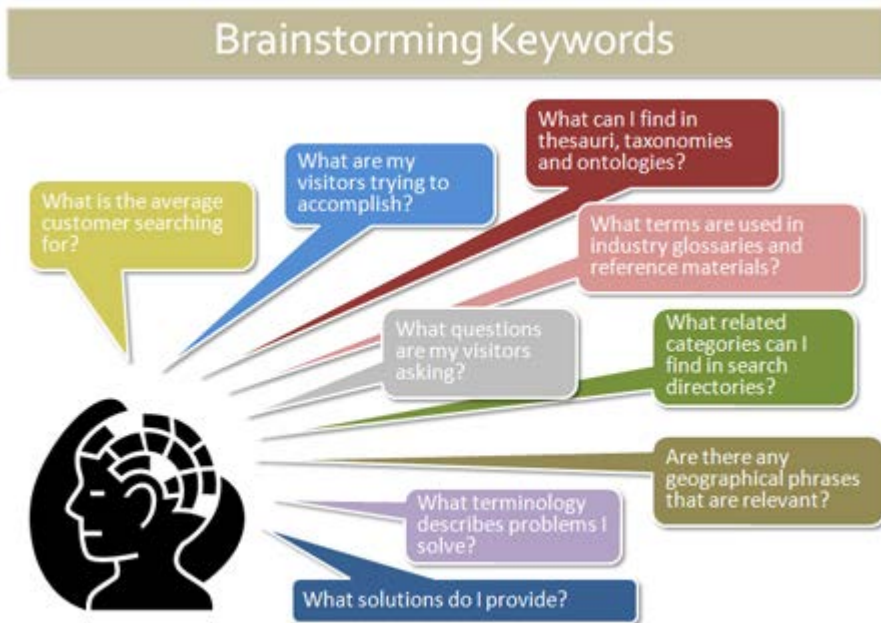

Before posting the webpage brainstorm any other keyword ideas that come to mind. English, for example, is one of those languages where there are many ways to say the same thing. This means it is very useful for you to keep a thesaurus handy because, for example, while you may want to sell vacuum cleaners, British clients might be googling hoovers and might not find your site.

## 1.32 Tagging



Tagging is a way of linking certain keywords to your text without having to use them in the text itself. The origin of this term comes from spray-paint graffiti artists who would put their name or signature on a piece, which they called tagging. The internet version, however, of tagging webpages is not so antisocial and when done right, is not seen as a blight on society.

There are several different ways of employing tags to a webpage. The first type is the Meta tags, the second is the description tag and finally there is the title tag.

### **Meta Tags**

Meta tags, also called Meta elements, are contained within the HTML code, the code behind your page that allows web browsers to reproduce how your page looks, that helps to describe some facets of your page to search engines. These short notes are located within the header of the HTML code and they should not be over looked.

Meta tags can be used to define a number of parts of your webpage. For



example:

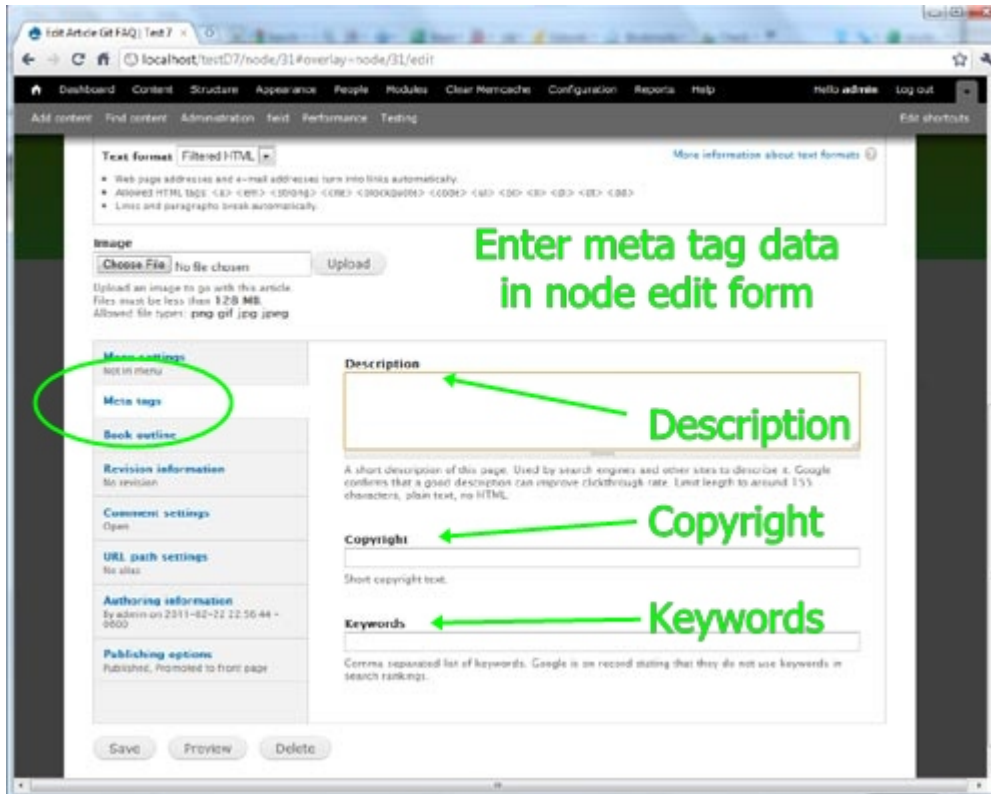

1) `<meta http-equiv="Content-Type" content="text/html" >`

This is used to define the header of your text. All you have to do is replace “content type” with the header title.

2) `<meta name="keywords" content="wikipedia,encyclopedia" >`

The keywords code is used for your keywords as described previously.

3) `<meta name="zipcode" content="45212,45208,45218" >`

By entering your zip or postal code, you can add the location of your business. This is vital for location-based businesses.

```
4) <meta http-equiv="Content-Type" content="text/html; charset=UTF-8" >
```

This is the Meta for basic text.

In the 1990s, search engines used Meta data to categorize websites and to correctly catalogue them. Marketing companies then caught on and used the Meta data as a means of promoting the website on the sly. In modern times, the Meta tags are less respected by spiders and so should be used with only the facts, no spam.

## Description Tag

[George Cayley - Wikipedia, the free encyclopedia](https://en.wikipedia.org/wiki/George_Cayley)

[en.wikipedia.org/wiki/George\\_Cayley](https://en.wikipedia.org/wiki/George_Cayley)

Sir **George Cayley**, 6th Baronet (27 December 1773 – 15 December 1857) was a prolific English engineer and one of the most important people in the history of ...

[General engineering projects](#) - [Flying machines](#) - [Memorial](#) - [See also](#)

[FLYING MACHINES - Sir George Cayley](http://www.flyingmachines.org/cayl.html)

[www.flyingmachines.org/cayl.html](http://www.flyingmachines.org/cayl.html)

Sir **George Cayley** is one of the most important people in the history of aeronautics. Many consider him the first true scientific aerial investigator and the first ...

The description tag is a short informational piece that describes either your webpage or your website. Description boxes turn up all over the place from websites to page descriptions on Facebook and description boxes in advert submission pages. As the picture shows you above, a good description that fits a keyword search perfectly will give you two lines of text on a Google search return. This could be the difference between getting a hit and getting missed.

There are simple rules to follow when writing a description tag:

First, decide upon a single keyword or keyword phrase.

Second, keep the description short and focused.

Third, edit the description to make sure it uses simple sentences.

Fourth, do not spam it with keywords

Fifth, do not make a sales pitch, but go for accuracy instead.

## Title Tag



The title tag is simply the title piece of your page. This should appear in two places. First, at the top of your webpage and second, in the URL bar at the top of the browser.

When you create the webpage, you will need to create a place for it within your website. This means you need to know the title of your page before you create it. Keep the title simple and functional as such titles are easier for search engines to pick up.



As the above picture demonstrates. The page title and the URL should be simple and similar. Many webpages can be defined by their function such as “about us” and “contact us” or “products,” while blog posts are subject based such as “meet the vacuum 500” and so on.

Some webpage creation platforms such as Wordpress will allow you to change the URL of a given page or blog post. Furthermore, you can decide how you want the URL to be defined. This means as well as including the title, you can add the date the page or post was added to the URL to help search engines place it.

You will find this under **permalink settings** in the Settings section of your Wordpress dashboard at the bottom left:

<input type="radio"/> Default	<code>http://markwollacott.com/?p=123</code>
<input checked="" type="radio"/> Day and name	<code>http://markwollacott.com/2012/01/21/sample-post/</code>
<input type="radio"/> Month and name	<code>http://markwollacott.com/2012/01/sample-post/</code>
<input type="radio"/> Numeric	<code>http://markwollacott.com/archives/123</code>
<input type="radio"/> Post name	<code>http://markwollacott.com/sample-post/</code>
<input type="radio"/> Custom Structure	<input type="text" value="/%year%/%monthnum%/%day%/%postname%/"/>

As you can see, there are five structural options. The first is the default setting which uses a random code. The second uses the day the post was published and the name of the post, the third uses month and name, the fourth is numeric and the fifth can be customized. If you are uncomfortable with customization we suggest you use “day and name” or “month and name.”

## 1.33 Image Search Optimization (ISO)



Image Search Optimization, or ISO, is related to SEO, but is related to image searches. Perhaps some people will wonder why searching for a photograph, cartoon or diagram is important for your website, well, many image searches lead directly to people accessing the website where from the image originates.

First, you need to choose your images wisely. There are no set rules for choosing images, but you have to bear in mind several factors.

First, is the image suitable for your viewers? Take into consideration your likely customer and fan base, plus rules and restrictions on content. Adult content, for example, is not for everyone.

Second, check whether you have the legal right to use the image. If you are not using the image in a commercial sense, you may be ok. Google's Advanced Image Search (for example), allows you to filter out images that cannot be reused. If the image will be used commercially, then you can filter in only images that are labeled for commercial reuse.

Third, consider the story the picture is telling. Does this picture accurately reflect the content of your web page? Furthermore, does it look right when compared to the background, the website's layout and other aesthetic features?

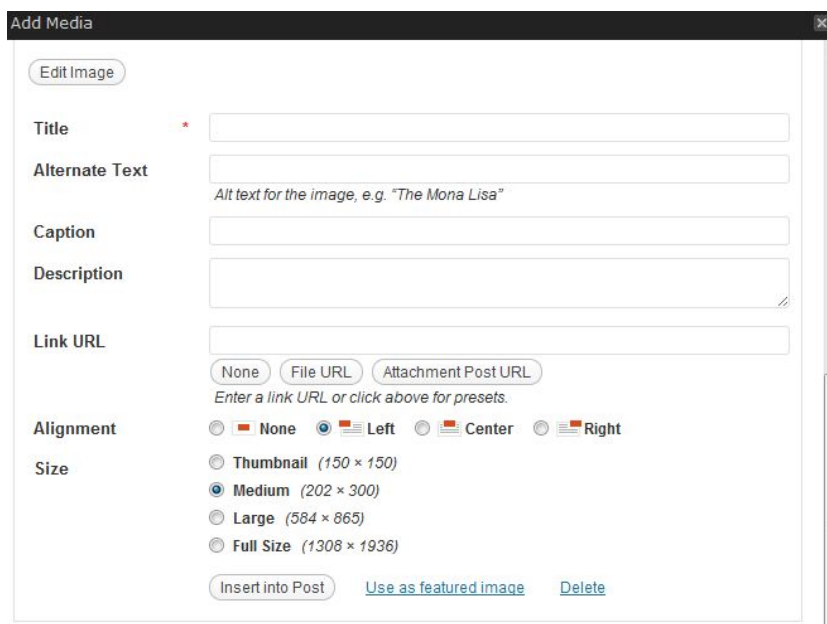

The image shows a screenshot of the 'Add Media' dialog box in WordPress. The dialog has a title bar with 'Add Media' and a close button. Inside, there is an 'Edit Image' button at the top left. Below it are several text input fields: 'Title' (with a red asterisk), 'Alternate Text' (with a small icon and a hint: 'Alt text for the image, e.g. "The Mona Lisa"'), 'Caption', and 'Description' (with a small icon). Below these is a 'Link URL' field and three radio buttons: 'None', 'File URL', and 'Attachment Post URL'. A hint below says 'Enter a link URL or click above for presets.' Underneath are four radio buttons for 'Alignment': 'None', 'Left' (selected), 'Center', and 'Right'. Below that are four radio buttons for 'Size': 'Thumbnail (150 x 150)', 'Medium (202 x 300)' (selected), 'Large (584 x 865)', and 'Full Size (1308 x 1936)'. At the bottom are three buttons: 'Insert into Post', 'Use as featured image', and 'Delete'.

When you add an image to your page, you might be presented with a box like this (from Wordpress). ISO is far simpler than SEO. In order to optimize your image you need to:

1. Provide a link URL to your photo. The best options are either by first putting your photo on a social photo sharing network like Flickr, or by linking back to where you go the image from (if you did not take it/make it yourself)
2. Add a few relevant tags to the image.
3. Add a brief description of the image and how it relates to the content in the article.

## 1.34 Internal Linking



Internal linking defines the internal structure of your website. Think of it as the tendons of your body, linking muscles to bones and vice versa, or like the smaller internal strands of a spider web.

There are several techniques for linking pages and blog posts together within your website. However, remember one thing, you do not have to link every page to at least one other page. If you include a plugin or program such as Google XML Sitemaps, you can make sure pages are found within your site regardless of their connectivity.

Techniques include:

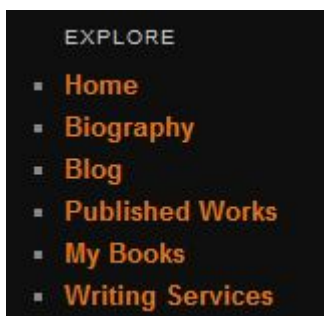

**Menus** are one of the most obvious forms of internal linking. Your menu structure depends on how many pages you have. Typically, this means having a



small menu at the top of the page beneath the header and/or a sidebar menu on the left or right. These contain the titles and links for the main areas of your website. Larger sites will include drop down sub-menus that link to smaller pages. Of course, it is possible to have sub-sub-menus, but be conscious of making the site too complicated or labyrinthine.

## In-Text Links

This is the most subtle way of linking pages and adverts into a web page. To create an internal link or hyperlink, simply highlight a relevant word (for example the product name), right-click in a word document or click the chain image and then paste the target URL. You can use these within the main text or as a “see also” section at the end.

## Tags and Categories



Many blogs and site building software programs allow the user to denote the category of the page or post, and to add tags (as discussed in 1.22). Some platforms like Wordpress allow you to add a sidebar element (called a widget) that lists the categories and creates a tag cloud of the most popular tags.

## Sitemaps

### Paperback Exchange Bookstore Site Map

Click on page to go there

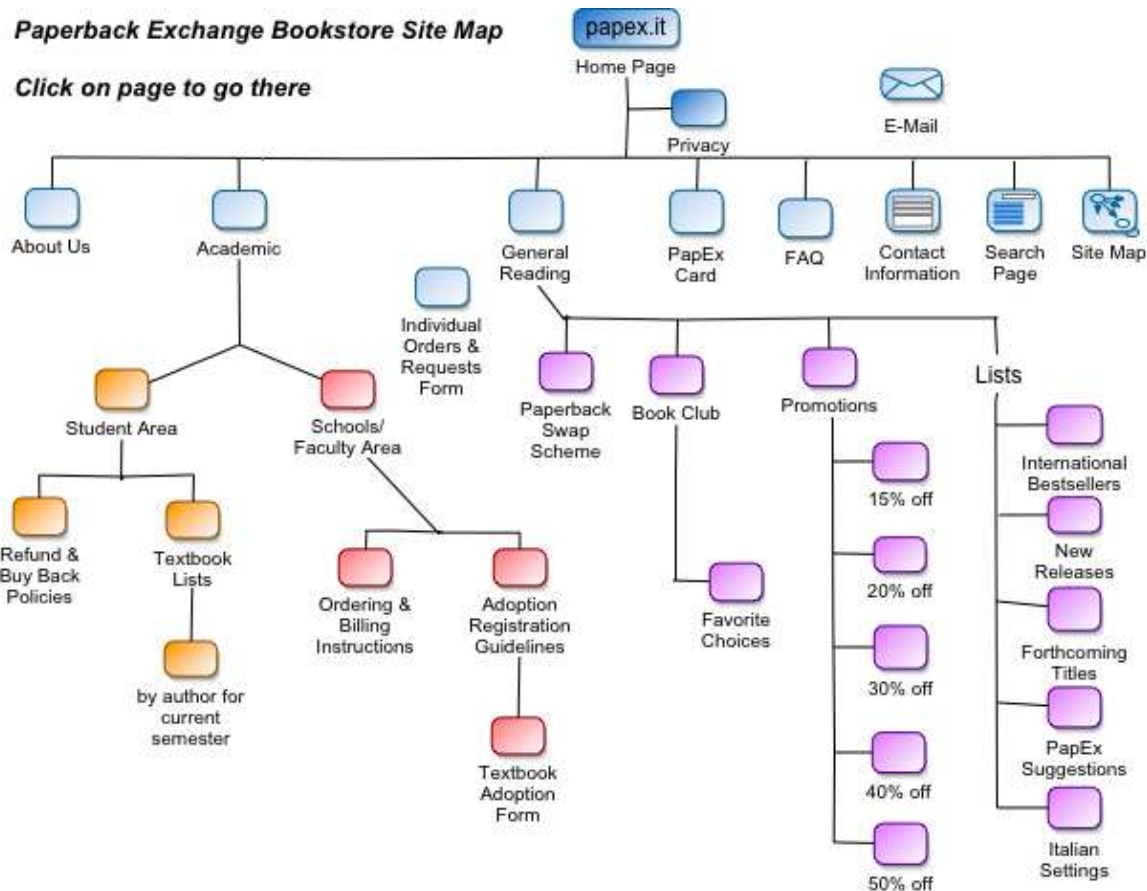

A sitemap literally provides users with a map of the whole site including pages that are not directly linked to other ones. The easiest way to do this is to install a program such as Google XHTML Sitemaps or to ask your web designers to do this for you.

The sitemap will allow users to follow a spider diagram like a blueprint. They will see how each section locks into another and how pages flow into other pages.

